

Requires the installation of a :

Gateway module

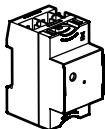

OR

Connected Starter Pack  
"... with Netatmo"

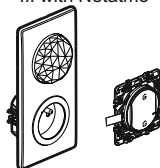

### Composition

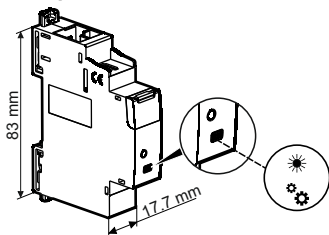

Connected energy meter

+

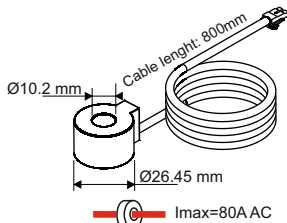

⚠ Pay attention to the direction of the current  
Measure coil

	<b>U</b>	<b>I</b> measure	<b>F</b> 	Accuracy 	Measure 
+5°C +45°C	100-240V~ 50 / 60Hz	80A MAX	2,4 à 2,4835Ghz <100 mW	+/-1% under 63A	Global & Per* circuit

CE Directive  
Compliant with the following European directive:

Low voltage directive  
(LVD) 2014/35/UE

Electromagnetic compatibility  
(CEM) n° 2014/30/UE

\*Functionality available only if several connected energy meters are installed.

### Imperative security precaution



Failure to strictly comply with the installation and use conditions may result in risk of electric shock or fire.

# 1 Preparation, connexion

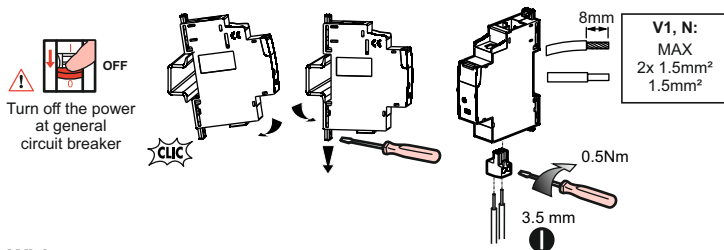

## Wiring

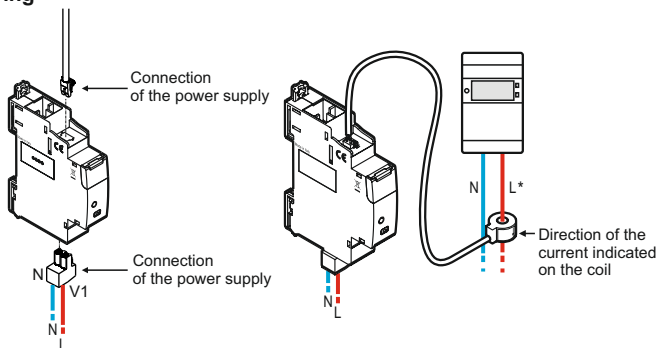

A circuit breaker for the Energy meter is necessary

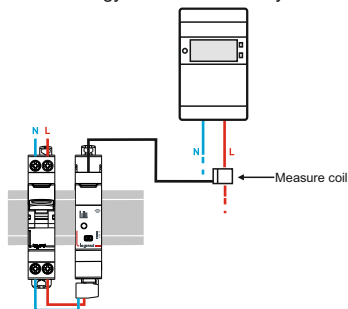

\*: Do not use on a three Lines electrical installation.

— N (neutral) = blue      — L (Line) = Everything but blue and green/yellow

**2** Add the **Energy meter** in a connected installation

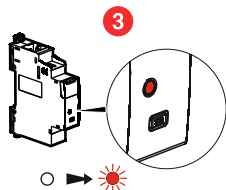
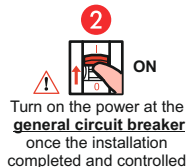
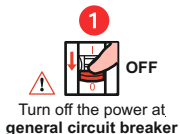

**3** **Press and hold** the Gateway module settings button, or in the center of the General Scenario Wireless Command until the LED turns green, then release the button.

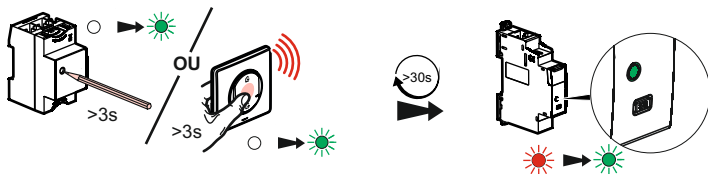

The configuration LEDs of " ... with Netatmo " devices must all light up in fixed green.

**4** Complete the installation

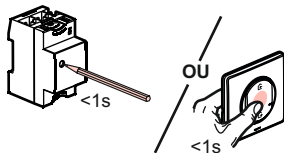

**Briefly press** the setting button on the Gateway module (or in the center of the General Scenario Wireless Command) to finalize the installation. All devices LED go OFF.

**5** Finalize the installation in the Legrand Home + Control app

To add this connected product and peripheral items in your connected installation, you must follow the instructions:

- with Legrand Home + Control app

(Parameters/Add new product)

- or consult the guides and instructions sheets on [legrand.fr](http://legrand.fr)



## Reset an Energy meter to remove it from a connected installation

Press the button for more than 5 seconds  
configuration of the Energy meter until  
the configuration indicator lights up solid red.  
It is no longer associated with the Gateway module  
/ Control socket.

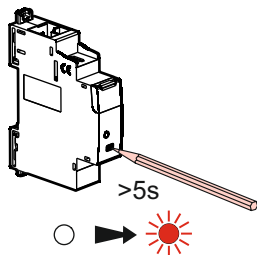

[www.legrand.fr/reference/412015](http://www.legrand.fr/reference/412015)

LEGRAND - Pro and Consumer Service - BP 30076  
87002 LIMOGES CEDEX FRANCE • [www.legrand.com](http://www.legrand.com)

## EU SIMPLIFIED DECLARATION OF CONFORMITY

The undersigned,

**Legrand**

declares that the radio equipment listed on this instruction sheet  
are compliant to the directive 2014/53/UE.

The full text of the EU declaration of conformity  
is available at the following website:

[www.legrandoc.com](http://www.legrandoc.com)